

# Data Sheet



Article number: 025848460076

Description: Norma Connect pipe coupling  
COMBI GRIP GL W2 Ø76,1/75 NBR 16 bar

## Measures

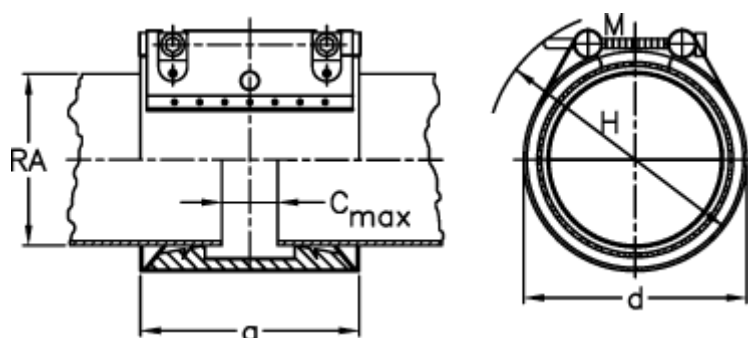

a = 98.0

C max with insertion band = 25

d = 95

H = 115

M (screw) = M10

Nominal pressure (bar) = 16

RA = 76,1/75,0

RA min-RA max metal = 75,0-76,9

RA min-RA max plastic = 74,0-76,0

Weight a piece = 1.5